

Pioneer *sound.vision.soul*



6 - DVD/VCD/CD/MP3/WMA

XDV-P650

SUPER TUNER III D



• 가	6
• DVD	6
•	8

01		4
		4
		5

02		6
		7
		7
		7
		7
WMA		8
DVD		8
		9
		9
		9

03		11
		11
		11

04		12
DVD		13

05	ON/OFF	15
	/	15

06	DVD	17
	DVD	17
	DVD	18
	DVD	18
	DVD	18
	()	18
		18
		18
	Chapter	19
		19
	()	19
	()	20
	()	20
	가	20
	DVD	20
		21

07	CD	24
	CD	24
	PBC	24
		25
	CD	25
		25
		25
		25
		26
	1	26

08	CD	29
	CD	29
	CD	29
		30

09 MP3/WMA

MP3/WMA	32
MP3/WMA	33
MP3/WMA	33
MP3/WMA	33

10 DVD

DVD	36
가	36
	36
	37
	37
ON/OFF	38
	38
	38
	39
	40
	40

11

	42
	43
	44

가

	45
	47
DVD	48
DVD	48
CD-R/CD-RW	48
	49
MP3 WMA	49
MP3/WMA	51
DVD	52
	53
	56

가 57



- 1.
- 2.
- 3.
- 4.
5. (i)
- 6.
- 7.
- 8.
- 9.
- 10.



, (ii) 가

가

, (iii) DVD TV (

가

DVD

DVD, CD, TV

DVD, CD, TV

, VIDEO VIEWING IS NOT AVAILABLE WHILE DRIVING() 가

가

DVD TV



DVD TV

가



ACC 가



• 가

가

“ 1 ”

1

•

•

• 가

• 가

• 가

가

가 DVD, CD, CD

DVD



CD



CD



• DVD DVD Format/Logo License Corporation

• 가

DVD

DVD

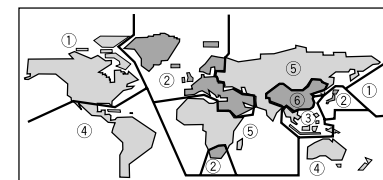



MP3
CDROM/CD-R/CD-RW (ISO9660 1 / 2
) MP3

가 () , /
- ()
가 가
<http://www.mp3licensing.com>

WMA
CD-ROM/CD-R/CD-RW (ISO9660 1 / 2
) WMA

가

NTSC/PAL
NTSC/PAL

가

DVD
DVD DVDR/RW ()

/DTS
Dolby Laboratories
Dolby , Pro Logic , DD Dolby
Laboratories
DTS Digital Theater Systems, Inc

PBC
PBC CD
()

CD
CD/CD-R/RW 가

가



DVD



WMA

DVD

Windows Media

가

DVD



Macrovision Corporation
가

Macrovision Corporation , 가
Macrovision Corporation

DVD

DVD



2))

2

3

16 : 9 LB (: :)



가

WMA



Windows Media

WMA

WMA Windows Media Audio
가

WMA Windows Media
version 7
Windows Media Windows
가

DVD

가

()
()

(Mode)

1. OFF

2.

RESET

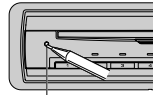

IP BUS

IP BUS

IP BUS

STAND ALONE()

(+), (-)

CD

가

DVD,

CD,

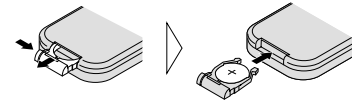

RESET
가

:

가

() 가



CR2025 (3 V)

,가,

가

가



가

가

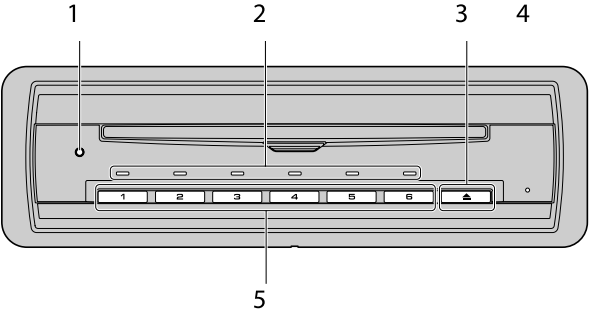
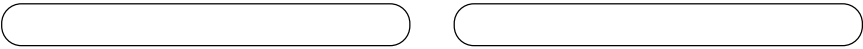

DVD

1. RESET() ()
2. ()
3. 가 .
4. .
5. 1-6 () .

, 5.1 DVD
 가
 Dolby Laboratories
 Dolby , Pro Logic , DD
 Dolby Laboratories



DTS Digital Theater Systems, Inc



()

(, AVG-VDP1)

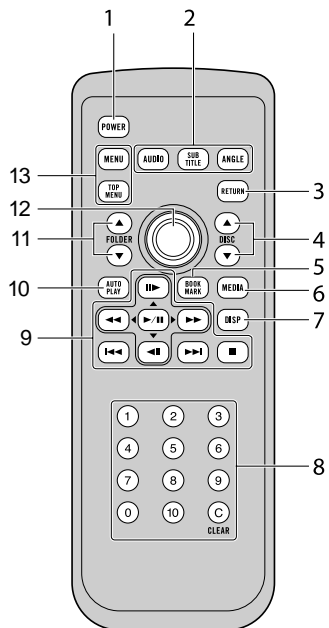

1	POWER	
2	AUDIO	DVD
	SUBTITLE	DVD
	ANGLE	DVD
3	RETURN	PBC PBC ()
4	/ ()	/
5	BOOKMARK	() 18
6	MEDIA	MP3/WMA CD-EXTRA MIXED-MODE CD (CD-DA) MP3/WMA (CD-DA) MP3/ WMA (ROOT:) 01 (ROOT) 02

7	DISP	.
8	0-10	, Chapter, .
	C	0-10
9	PLAY/PAUSE (/)	.
	REVERSE ()	().
	FORWARD ()	().
	PREVIOUS ()	(Chapter)
	NEXT ()	(Chapter)
	STEP (/)	DVD/VideoCD 1
10	AUTO PLAY	DVD ON/OFF.
11	/ (FOLDER)	/
12	Joystick	, , .
13	MENU	DVD DVD
	TOP MENU	DVD



ON/OFF

ON

IP BUS

1. 가

2. DVD SOURCE

STAND ALONE()

1. 가

2. POWER()



(17 DVD 가)

OFF

IP BUS

SOURCE()

POWER()
ON

OFF 가 OFF



POWER()

ON
OFF

IP BUS

가 DVD가
DVD

가 ON/OFF
가
ON/OFF

STAND ALONE
POWER

1. DVD 1-6
가

가	
가	

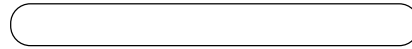

가	
가	
가	
가	

가

2

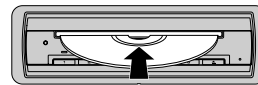

가

DVD 가
Chapter DVD . 20



• DVD 12-cm
8-cm
가

12cm	8cm	8cm
	-	-

- 가 가 6
- 가 ,
- 가 -
- ERROR-02 가 , 46
- DVD () 18
- 가
- 가 DVD 1-6 / ()

가

1. DVD 1-6

가

2. 가

_(⊙)

DVD

DVD
 DVD
 DVD
 21
 1. DVD
 1-6
 , 15
 / ()
 (DVD 가)
 , DVD 1-6 / ()
 2. / ()
 3. | Chapter | Chapter
 Chapter
 4. /
 5. /
 / 가
 / II
 가
 / 가

DVD

DVD
 • 가 MENU() TOP
 MENU()
 •
 1.
 2.
 10 DVD
 DVD 0-10
 0-10
 • 3 , 3
 • 10 , 10 0
 • 23 , 10, 10, 3
 C 가

DVD

/ ()
 8
 DVD 가
 , / II
 II 가 / II
 II
 , (⊙)
 II 가
 , (⊙)

()

BOOKMARK()
 6 가
 BOOKMARK
 DVD 가
 , / II
 II
 가 / II
 II
 , (⊙)
 •
 •
 • 가
 1. II

() 가 /||

2. || || ||

|| 가 :

1/16 - 1/8 - 1/4 - 1/2



- 가 ()
- ()
- 가
- 가

가

가 0-10

8

- 3 , 3
- 10 , 10 0
- 23 , 10, 10, 3

Chapter

Chapter

Chapter

0-10

Chapter 8 Chapter

- 3 , 3
- 10 , 10 0
- 23 , 10, 10, 3

()

DVD (Dolby Digital, DTS DVD)

/

AUDIO()

AUDIO



- DVD ()

- DVD /

- SET-UP() /

37

- DTS 가

DTS DTS

- Dolby D 5.1ch DVD

- / AUDIO

()

DVD

SUBTITLE()

SUBTITLE



- DVD ()
- DVD
- SET-UP() 36
- / SUBTITLE

()

DVD ()

ANGLE ANGLE() 가



- DVD ()

ANGLE

가

DVD

가 RETURN



DVD

DVD

DVD DVD 가

- DVD

PLAY() ON AUTO

AUTO PLAY

DVD



Chapter 1

1 2

1.

DISP

DISP 가

1 - 2 -



• Chapter 1 2 , Chapter,

1 , Chapter,

• / DISP

Chapter

1.

2. 0-10

Chapter

- 3 , 3
- 10 , 1 0
- 23 , 2, 3

Chapter 가 10 10

()

• 21 43 , press 2, 1, 4, 3

• 1 11 , 71 00

- 10 가 10 C

3. 가

8

가



• 가 , MENU() TOP MENU()

• , (⊖)

Chapter

Chapter

19

, Chapter

1. DISP

2

(, , Dolby Digital)

2.

1.

2.

3.

- -
- Chapter - Chapter

Audio 1 - Audio 2 - Audio 3



DVD

Subtitles 1 - Subtitles 2 - Subtitles 3

Angle 1 - Angle 2 - Angle 3

1. DISP

2



DVD

2.

3.

• Dolby D 5.1ch DVD

- L+R -
- L -
- R -



PCM

1. DISP

2.

3.



- 1-6 가
- / ()

CD

DVD CD
 26 CD

1.

1-6 DVD

PBC 가 CD()
 / ()

2.

Chapter

3.

가
 , DVD 1-6
 / ()

/ 가
 , /||
 가
 /
 가

PBC

PBC () CD ,

PBC 가
 0-10

- 3 , 3
- 10 , 1 0
- 23 , 2, 3
- 10 가 10
- C 가
- PBC RETURN

가
 | 가
 , 0-10



- -CD PBC
- PBC () CD

CD (PBC 가)
 /||

CD
 ||가 /||
 /||

 (⊙)

|| 가 /||

 (⊙)

- 가

1. || (■■■) 가 /||

2. || || || 가
 1/16 - 1/8 - 1/4 - 1/2

 가 (⊙)

- 가

0-10
 8

- 3 , 3
- 10 , 1 0
- 23 , 2, 3 C

 (⊙)

- CD PBC

AUDIO
 • L+R -
 • L -
 • R -

 가

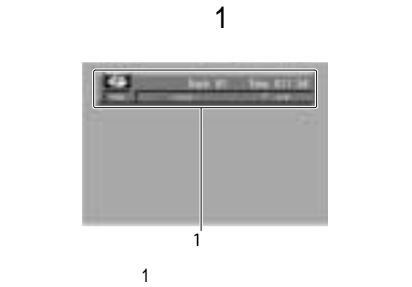

PBC () CD
 , PBC ON

- -CD PBC

1.

DISP
 가

Chapter

•PBC () CD

•

1.

2. 0-10

•3 , 3
•10 , 1 0
•23 , 2, 3
- 10 10
Chapter 가 10

()
•21 43 , 2, 1, 4, 3

•1 11 , 71 00
7, 1, 0, 0
- 10 가 10 C

3. 가



•

•

25

1.

2.

•
•



• CD

•PBC () CD

1.

2.

•L+R -
•L -
•R -

1. DISP

2.

가

3.



•1-6 가
• / ()

CD

DVD CD
 1. DVD
 1-6
 , 15
 / ()
 가
 , DVD 1-6
 / ()
 2. , |
 |
 |
 3. / , /
 / 가

 MP3/WMA CD-EXTRA MIXED-MODE CD (CD-DA) MEDIA() (CD-DA)
 MP3/WMA

CD

CD 가 /||
 ||가 /||
 /||

CD

 1.
 DISP 가
 1 - 2 -
 2 CD TEXT
 1.
 2. 0-10
 • 3 , 3
 • 10 , 1 0
 • 23 , 2, 3
 - 10 가
 10

C

3. 가
 1.
 2.
 • -
 • -

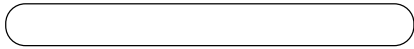
 /
 CD
 1.
 2.
 • ON -
 • OFF -



MP3/WMA

가
/||



1

MP3/WMA

||가
/||

1.

DISP

DISP
가

1- 2-

1.

2. 0-10

- 3 , 3
- 10 , 1 0
- 23 , 2, 3
- 가 10 10

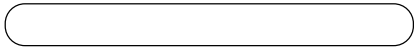

C

3. 가

1.

2.

MP3/WMA 가
: (), ()
, ()

- ON -
- OFF -

1.

2.

10
10

- -
- -
- -

1.



2.

가 DISC()
가 FOLDER()

- ON -
- OFF -

10 ()

• MPE/WMA (CDDA)

3.



MP3/WMA

MP3/WMA

1. DISP

2

1. DISP

2.

2.

3.

3.



- 1-6
- / ()

- Folder Name -
- File Name -
- Track Title -
- Artist Name - 가
- Album Title -
- Comment -
- Bit Rate - WMA

가 CD TEXT
, No XXXX가 (,
가).

22

가 22 가

DVD

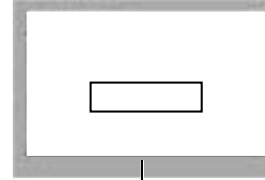

DVD

1. SET-UP

1.

2 가 MENU
. SET-UP 가

3

LANG., PICT. GEN.



SET-UP MENU가
, SET-UP MENU가

MENU

SET-UP MENU

RETURN

DVD

1
SUB TITLE LANG.
TITLE LANG.

LANG.
. SUB

2

가

3

2

1

4

가



- 가
- 가
SUBTITLE
(20
(-)
SUBTITLE
- RETURN
가

가

(OTHERS)

OTHERS 가 . 52 DVD



- 가
- 가 AUDIO . (19 (-))
- AUDIO .)
- RETURN
- OTHERS OTHERS



C

1 AUDIO LANG. LANG. AUDIO LANG.

2 가

3 1 MENU LANG. LANG. MENU LANG.

2 가

1 가

4. 가

1 MENU LANG. LANG. MENU LANG.

2 가

3

2

1 가

4 가



- 가
- RETURN
- OTHERS OTHERS

ON/OFF

DVD

ON OFF

1 ASSIST ASSIST가 LANG.

2 OFF ON

1 ANGLE ANGLE가 PICT.

2 가



- ANGLE . (20 (-))
- AUDIO
- RETURN

가 16:9 (TV 4:3 TV

) 가 TV LETTER BOX PANSKAN . 16:9

1 TV ASPECT TV ASPECT 가 PICT

2 TV ASPECT 가

3. ASPECT TV

TV ASPECT TV ASPECT

• 16:9 - (16:9)

• LETTER BOX -

• PANSKAN -

4 TV ASPECT 가



• PANSKAN
PANSKAN
LETTER BOX

16:9 LB

(8 가 .)
TV ASPECT

• RETURN

DVD

가
가

1 PARENTAL
PARENTAL

가 GEN

2

가

3 0-9

4

가

5

• LEVEL 8 - 가 ()

• LEVEL 7 LEVEL 2 - 가

• LEVEL 1 - 가

6



•

•

가

• RETURN

1

PARENTAL
PARENTAL

GEN

2

가

3 0-9



4

가

C

5

6



RETURN

C 10

가

1

DIGITAL OUTOUT
DIGITAL OUTOUT

GEN

2

가

3

• STREAM - 가

• LPCM - () 가

PCM 가

4



• DTS LPCM PCM , DTS

•

LPCM

가 가

(DEQ-P7650)
STREAM

PCM



• , 48KHz

• , 96KHz



가

1 OUTPUT SELECTION GEN
OUTPUT SELECTION

2 가

3

- 48KHz - 48KHz . 96KHz 48KHz
- 96KHz - 가 . 96KHz

4



- 96KHz , 96KHz
- CSS (Content Scrambling system) , 96KHz
- 가
- (DEQ-P7650) 486KHz , 96KHz
- 가

IP BUS , 가
, IP BUS

IP BUS

1

2 DVD가 SOURCE 가



- POWER OFF OFF
- POWER OFF

		DVD	CD	CD	MP3/WMA
1-6		()			
		/			/
		/			
		(Chapter)		(Chapter)	
		*2			
BAND/ESC				MP3/WMA (CD-DA)*3	
				01 (ROOT)*4	
FUNCTION (FUNC)					



- MP3/WMA 가
- 01 (ROOT) (CD-DA)*3

		DVD	CD	CD	MP3/WMA
FUNCTION 1					
FUNCTION 2		/			
				ON	OFF
FUNCTION 3				ON	OFF
FUNCTION 4					
AUTO.MANUL		AUTO		MANUAL	

		()
가		
	가	가 가
	가	RESET (9)
	가	(48)
	가	
	가	
가		
	가	가
()		가
		가
가 ()	가 가	
가		
	가	
	가	
		(38)
(ACC 가)	가	

DVD

		()
	가 가	가 (6, 54)
가		(39)
	가	(39)
		C 10 (40)
()가	DVD	
	DVD	
SET-UP MENU	DVD MENU SET-UP	SET-UP MENU 가
	DVD	DVD
	(가)	

CD

		()
PBC(Playback control) 가	CD PBC	PBC 가 CD
/	CD PBC	PBC CD 가

가

		()
ERROR-02		
ERROR-05		RESET
ERROR-A0		가
DIFFERE REGION DISC (REGION ERR)	가 가	가
NON_PLAYABLE DISC (NON-PLAY)	가	가
TEMPERATURE PROTECTION IN MOTION (TEMP)	가	가 가
PROTECTED CD	DRM(Digital rights management)	
TRACK SKIPPED	가 DRM WMA	

DVD

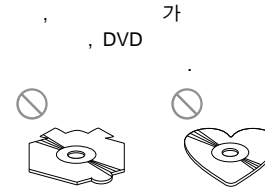

가
, DVD

()

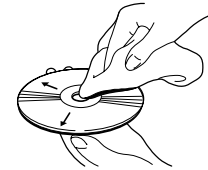

DVD 가 가 가 , DVD 가 , DVD

DVD 가 12cm 9 cm 가

12 - cm	8 - cm	12 - cm
	-	-

DVD

DVD 가
DVD 가
DVD-R/DVD-RW 가
DVD-R/DVD-RW () 가 (VR) DVD-RW 가 DVD-R/DVD-RW () DVD-ROM/DVD-RWM 가

CD-R/CD-RW

CD-R/CD-RW 가

MP3/WMA

MP3/WMA CD-ROM

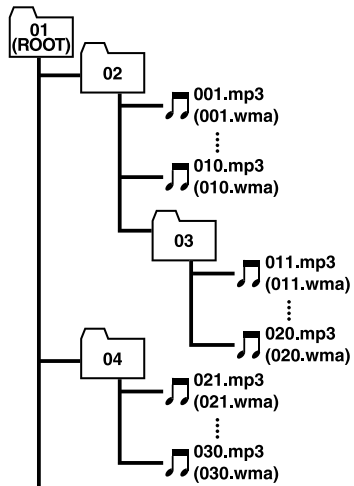

- 1. 1
- 2. 2
- 3. 3



MP3/WMA

가 . (

)
253

가

DVD

Language (code), input code	Language (code), input code	Language (code), input code
Japanese (ja), 1001	Guarani (gn), 0714	Pashto, Pushto (ps), 1619
English (en), 0514	Gujarati (gu), 0721	Quechua (qu), 1721
French (fr), 0618	Hausa (ha), 0801	Rhaeto-Romance (rm), 1813
Spanish (es), 0519	Hindi (hi), 0809	Kirundi (rn), 1814
German (de), 0405	Croatian (hr), 0818	Romanian (ro), 1815
Italian (it), 0920	Hungarian (hu), 0821	Kinyarwanda (rw), 1823
Chinese (zh), 2608	Armenian (hy), 0825	Sanskrit (sa), 1901
Dutch (nl), 1412	Interlingua (ia), 0901	Sindhi (sd), 1904
Portuguese (pt), 1620	Interlingue (ie), 0905	Sangho (sg), 1907
Swedish (sv), 1922	Inupiak (ik), 0911	Serbo-Croatian (sh), 1908
Russian (ru), 1821	Indonesian (in), 0914	Sinhalese (si), 1909
Korean (ko), 1115	Icelandic (is), 0919	Slovak (sk), 1911
Greek (el), 0512	Hebrew (iw), 0923	Slovenian (sl), 1912
Afar (aa), 0101	Yiddish (ji), 1009	Samoa (sm), 1913
Abkhazian (ab), 0102	Javanese (jw), 1023	Shona (sn), 1914
Afrikaans (af), 0106	Georgian (ka), 1101	Somali (so), 1915
Amharic (am), 0113	Kazakh (kk), 1111	Albanian (sq), 1917
Arabic (ar), 0118	Greenlandic (kl), 1112	Serbian (sr), 1918
Assamese (as), 0119	Cambodian (km), 1113	Siswati (ss), 1919
Aymara (ay), 0125	Kannada (kn), 1114	Sesotho (st), 1920
Azerbaijani (az), 0126	Kashmiri (ks), 1119	Sundanese (su), 1921
Bashkir (ba), 0201	Kurdish (ku), 1121	Swahili (sw), 1923
Byelorussian (be), 0205	Kirghiz (ky), 1125	Tamil (ta), 2001
Bulgarian (bg), 0207	Latin (la), 1201	Telugu (te), 2005
Bihari (bh), 0208	Lingala (ln), 1214	Tajik (tg), 2007
Bislama (bi), 0209	Laothian (lo), 1215	Thai (th), 2008
Bengali (bn), 0214	Lithuanian (lt), 1220	Tigrinya (ti), 2009
Tibetan (bo), 0215	Latvian (lv), 1222	Turkmen (tk), 2011
Breton (br), 0218	Malagasy (mg), 1307	Tagalog (tl), 2012
Catalan (ca), 0301	Maori (mi), 1309	Setswana (tn), 2014
Corsican (co), 0315	Macedonian (mk), 1311	Tonga (to), 2015
Czech (cs), 0319	Malayalam (ml), 1312	Turkish (tr), 2018
Welsh (cy), 0325	Mongolian (mn), 1314	Tsonga (ts), 2019
Danish (da), 0401	Moldavian (mo), 1315	Tatar (tt), 2020
Bhutani (dz), 0426	Marathi (mr), 1318	Twi (tw), 2023
Esperanto (eo), 0515	Malay (ms), 1319	Ukrainian (uk), 2111
Estonian (et), 0520	Maltese (mt), 1320	Urdu (ur), 2118
Basque (eu), 0521	Burmese (my), 1325	Uzbek (uz), 2126
Persian (fa), 0601	Nauru (na), 1401	Vietnamese (vi), 2209
Finnish (fi), 0609	Nepali (ne), 1405	Volap, k (vo), 2215
Fiji (fj), 0610	Norwegian (no), 1415	Wolof (wo), 2315
Faroese (fo), 0615	Occitan (oc), 1503	Xhosa (xh), 2408
Frisian (fy), 0625	Oromo (om), 1513	Yoruba (yo), 2515
Irish (ga), 0701	Oriya (or), 1518	Zulu (zu), 2621
Scots-Gaelic (gd), 0704	Panjabi (pa), 1601	
Galician (gl), 0712	Polish (pl), 1612	

Aspect Ratio()
TV

4:3 가 , 가
16:9 가 , 가

Bit Rate()
1 second

bps (bit per

가
(, MP3)
가

Chapter()
DVD

DVD

Dolby Digital()
5.1

DTS (Digital Theater System)
DTS 6

ID3 MP3 가 , 가
가 ID3

ISO9660 Format(ISO9660)
CD-ROM

. ISO9660

가
Level 1: 8.3 (8

), 가

Level 2: 31

(") 가
8

Extended format()

Joliet(): 64

Romeo(): 128

Linear PCM(LPCM)/Pulse code modulation(PCM(LPCM)/)

CD DVD
, DVD CD
() , DVD

m3u "WINAMP"
(.m3u) 가

MP3 MP3 MPEG 3
ISO (International Standard Organization)
(MPEG)

. MP3
1/10

MPEG Moving Pictures Experts Group(가)
. DVD

Multi-angle ()
TV

가 TV
DVD 가

Multi-audio (Multilingual dialog) ()
DVD 8

Multi-session()
Multi-session 가
CD-ROM, CD-R, CD-RW
. Multi-session
2 가

Multi-subtitle()
32 DVD

Optical digital output/input (/)

Packet write ()
가
, CD-R

Parental lock ()
DVD

Playback control (PBC) ()
(PBC) CD 가
(2.0). PBC CD

Region number()
DVD DVD 가
가 DVD DVD

Title()
DVD 가
가 , 1, 2, 3

VBR
VBR variable bit rate()
CBR (constant bit rate:)

WMA
WMA Windows Media Audio
가
WMA Windows Media Player 7
Windows Media
가 가

..... 14.4 V DC (:
12.0 V ~ 14.4 V DC)
..... 4.0 A

DVD :
(W H D):
DIN
Chassis 178 50 161 mm
Nose 188 58 21 mm
D
Chassis 178 50 166 mm
Nose 170 46 16 mm
..... 1.7 kg

Hideaway :
(W H D) 179 28 100 mm
..... 0.5 kg
..... DVD , CD,

:
..... 3
& 4
가 DVD , CD,
, CD-ROM
(MP3, WMA)

:
..... 44.1/48/96 kHz
..... 16/20/24;
..... 2 ()
MP3 MPEG-1 & 2 Audio Layer 3
WMA Ver. 7 & 8
(Windows Media Audio)

..... 1.0 Vp-p/75 W (-0.2 V)

..... 5 Hz ~ 44 000 Hz (DVD ,
96kHz)

- 97 dB (1 kHz) (IEC-A)
(CD : 96 dB (1 kHz) (IEC-A
))
..... 95 dB (1 kHz)
(CD: 94 dB (1 kHz))
..... 0.008 (1 kHz)
..... 1.0 V (1 kHz, 0 dB)





A
 Angle icon() 20, 38
 Aspect ratio(()) 38, 53
 Audio language() 19, 37

B
 Bookmark () 18

C
 Chapter 53
 Code number() 39

D
 Dolby Digital 7, 53
 DTS 7, 53

L
 Language code chart () 52
 Linear PCM (LPCM) (PCM (LPCM)) 53

M
 Menu language () 37
 MPEG 54
 Multi-angle () 20, 54
 Multi-audio () 19, 54
 Multi-subtitle () 20, 54

O
 Optical digital output/input
 (/) 54

P
 Parental lock () 39, 54
 PBC (Play Control) () 24
 Play Control (PBC) () 54

R
 Region number () 6, 54

S
 Subtitle language () 20, 36

T
 Title () 54
 TV aspect (TV) 38

V
 CD 6